

WELDED	CHECKED	FITTED	CUT
--------	---------	--------	-----

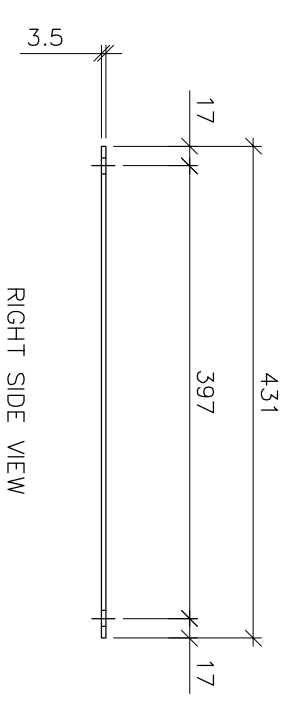
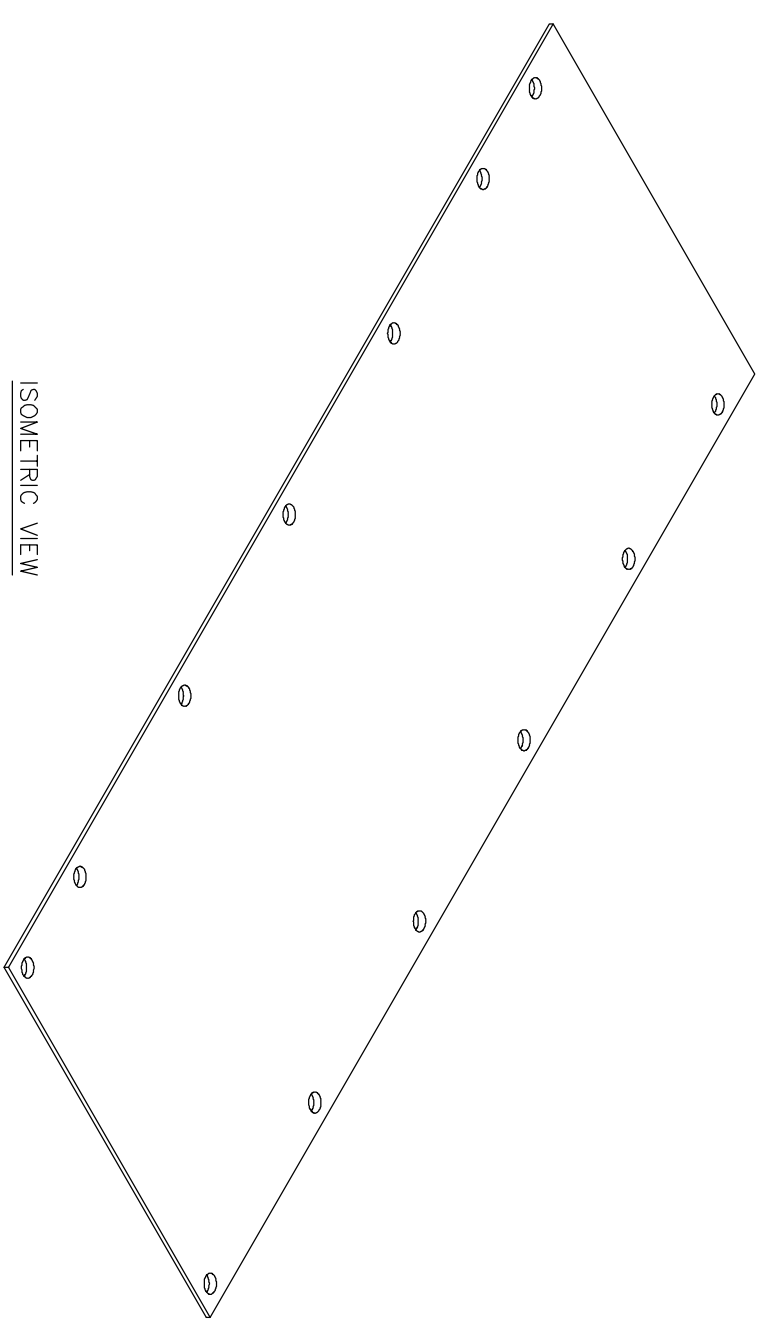
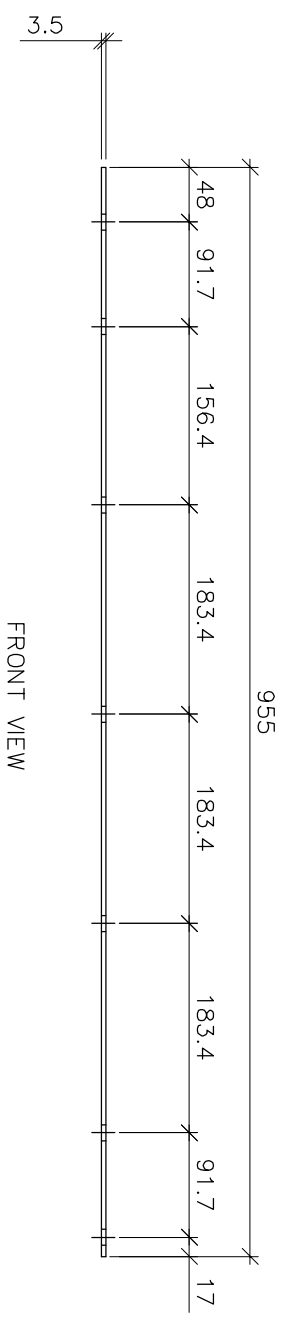
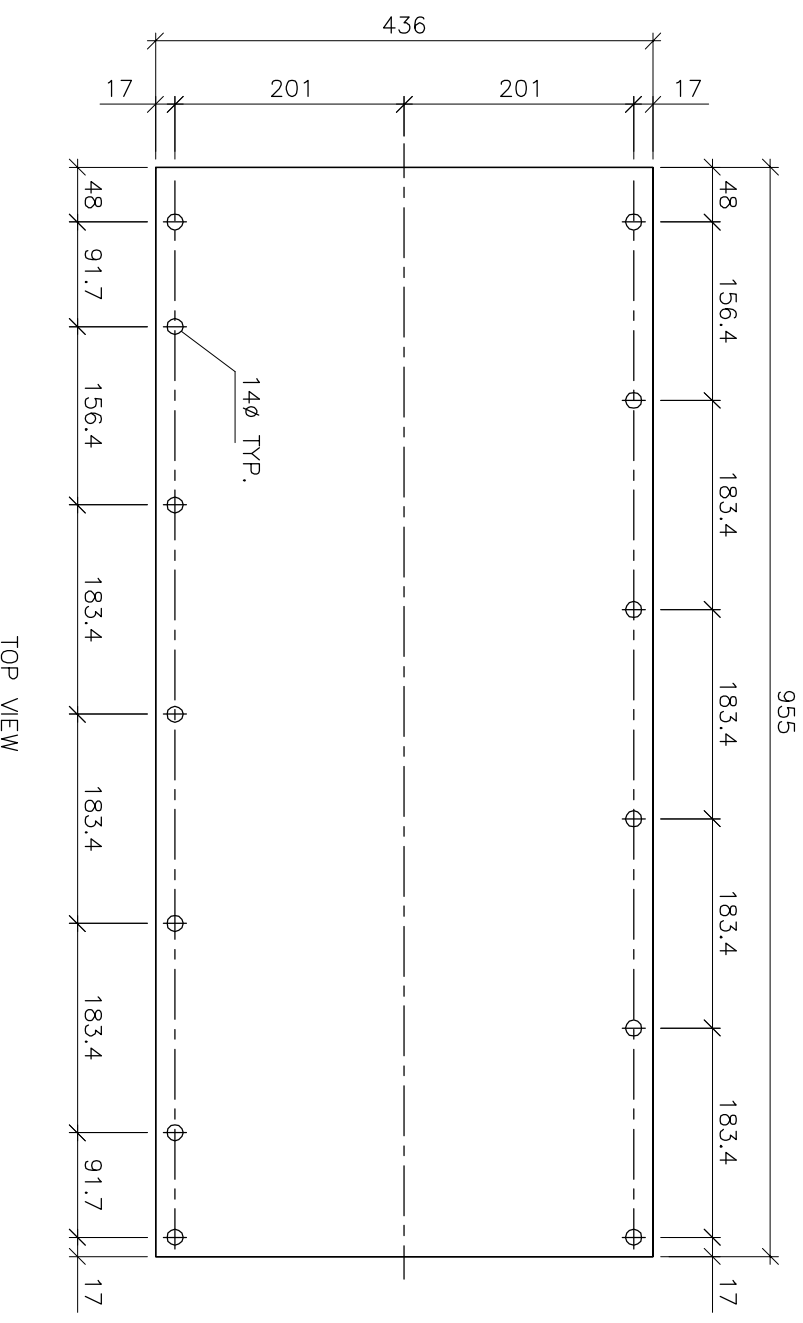

2 REQ'D (C)

MARK	QTY	DESCRIPTION	LENGTH	REMARKS	MARK	QTY	DESCRIPTION	LENGTH	REMARKS
C	2	PL 3.5mm 436	955						

QTY	TYPE	LEN
	FIELD BOLTS	
HOLES: 14 mm DIA		
PAINT: No Paint		
MAT. SPEC: 300W		

  

NUMBER	DATE	BY	SUBJECT
-	May 2008	RMC	436mm Side Panels
DRAWN	DHM	22/11/06	CUSTOMER David H. Manz
CHK'D BY			PROJECT STEEL MOLD
DWG REF			

  

Manz Engineering Ltd.		JOB #	DWG #
Alberta, Canada		98054	2
		REV #	0

WELDED	CHECKED	FITTED	CUT
--------	---------	--------	-----

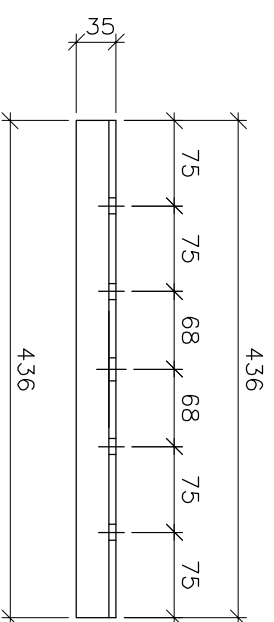

TOP VIEW

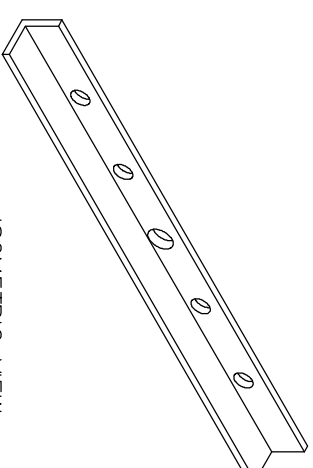

ISOMETRIC VIEW

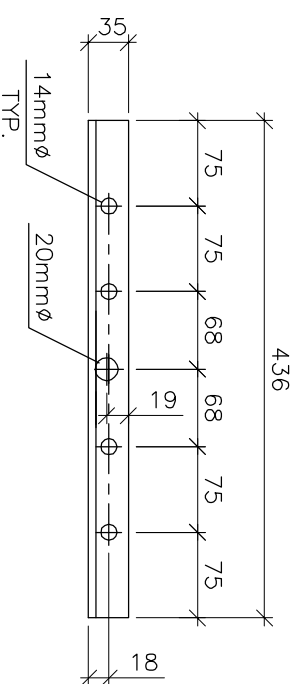

FRONT VIEW

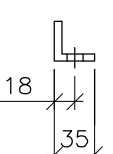

RIGHT SIDE VIEW

2 REQ'D (E)

MARK	QTY	DESCRIPTION	LENGTH	REMARKS	MARK	QTY	DESCRIPTION	LENGTH	REMARKS
E	2	L 35 x 35 x 6.35	436						

QTY	TYPE	LEN
	FIELD BOLTS	

HOLES: 14 & 20mm Dia  
 PAINT: No Paint  
 MAT. SPEC: 300W

NUMBER	DATE	BY	SUBJECT
—	May 2008	RMC	436mm Bottom Angle (Side Panels)
DRAWN	CUSTOMER David H. Manz		
CHK'D BY	PROJECT STEEL MOLD		
DWG REF	Manz Engineering Ltd. Alberta, Canada		
JOB #	DWG #	REV #	
98054	5	0	

WELDED	CHECKED	FITTED	CUT
--------	---------	--------	-----

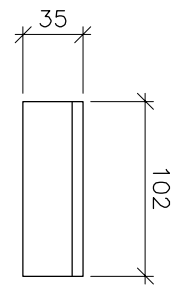

TOP VIEW

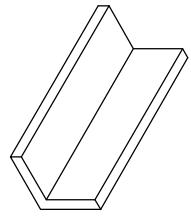

ISOMETRIC VIEW

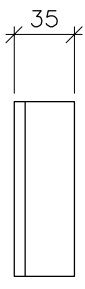

FRONT VIEW

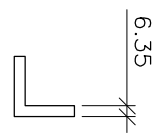

SIDE VIEW

4 REQ'D (F)

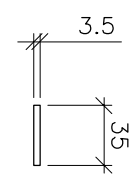

TOP VIEW

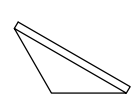

ISOMETRIC VIEW

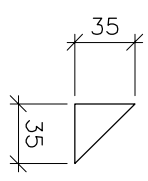

FRONT VIEW

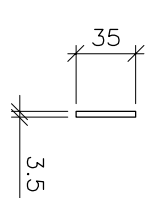

SIDE VIEW

8 REQ'D (G)

F	4	L 35 x 35 x 6.35	102						
G	8	PL 3.5 x 35	35						
MARK	QNT	DESCRIPTION	LENGTH	REMARKS	MARK	QNT	DESCRIPTION	LENGTH	REMARKS

QNT	TYPE	LEN
	FIELD BOLTS	
HOLES: 14 mm Dia		
PAINT: No Paint		
MAT. SPEC: 300W		

NUMBER	DATE	BY	SUBJECT
—	May 2008	RMC	Miscellaneous Steel Members
DRAWN			
CHK'D BY			
DWG REF			
PROJECT STEEL MOLD			
CUSTOMER David H. Manz			
Manz Engineering Ltd. Alberta, Canada			
JOB #	DWG #	REV #	
98054	5	0	

WELDED	CHECKED	FITTED	CUT
--------	---------	--------	-----

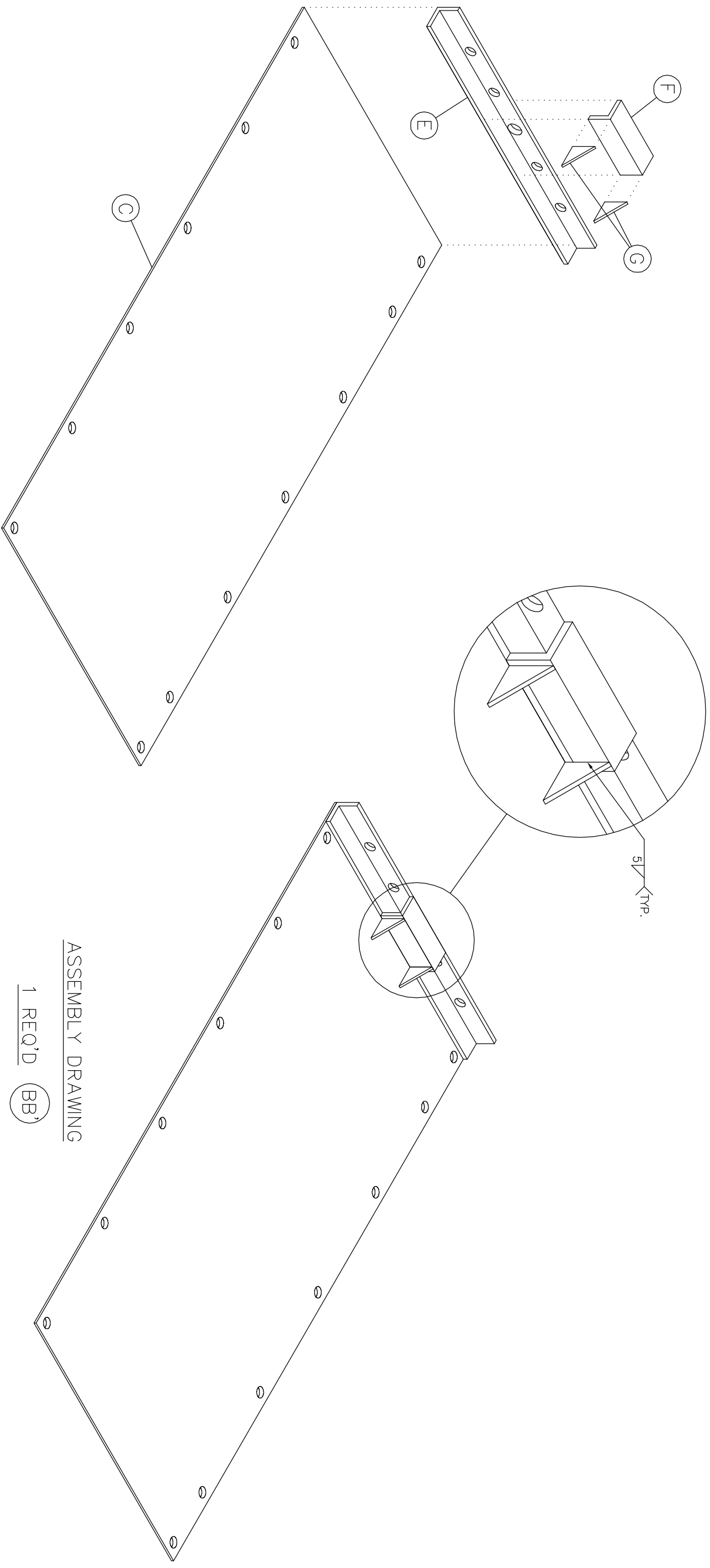

MARK	QNT	DESCRIPTION	LENGTH	REMARKS	MARK	QNT	DESCRIPTION	LENGTH	REMARKS
C	1	PL 3.5mm x 436	955						
E	1	L 35 x 35 x 6.35	436						
F	1	L 35 x 35 x 6.35	102						
G	2	L 3.5 x 35	35						

QNT	TYPE	LEN
	FIELD BOLTS	
HOLES: 14 mm Dia		
PAINT: No Paint		
MAT. SPEC: 300W		

NUMBER	DATE	BY	SUBJECT
—	May 2008	RMC	Right Side Wall Panel BB'
DRAWN	CUSTOMER David H. Manz		
CHK'D BY	PROJECT STEEL MOLD		
DWG REF			
Manz Engineering Ltd.			
Alberta, Canada			
JOB #	DWG #	REV #	
98054	6	0	